

Maximum of 50 monitors

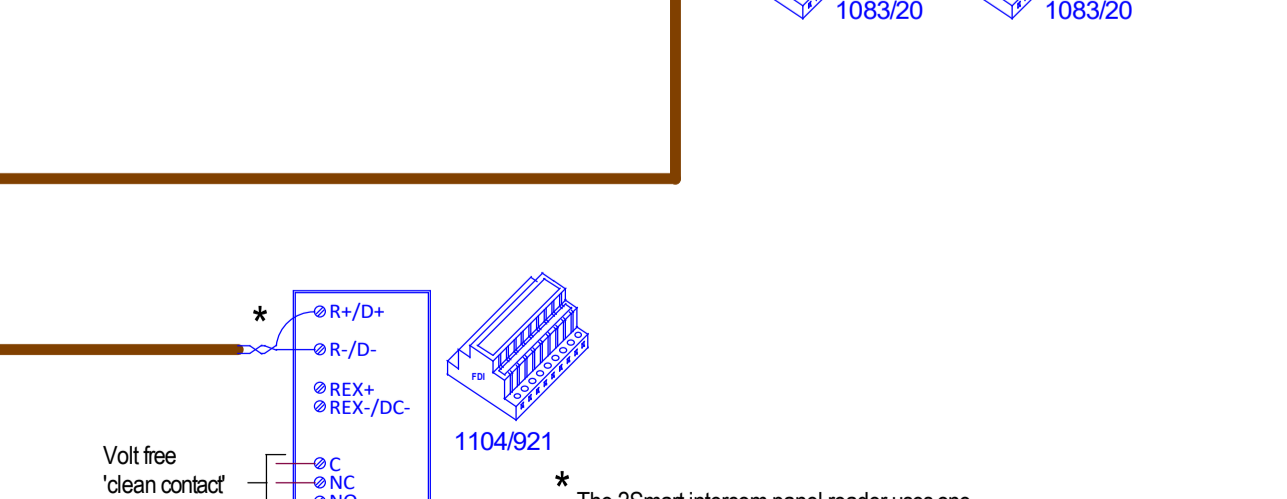
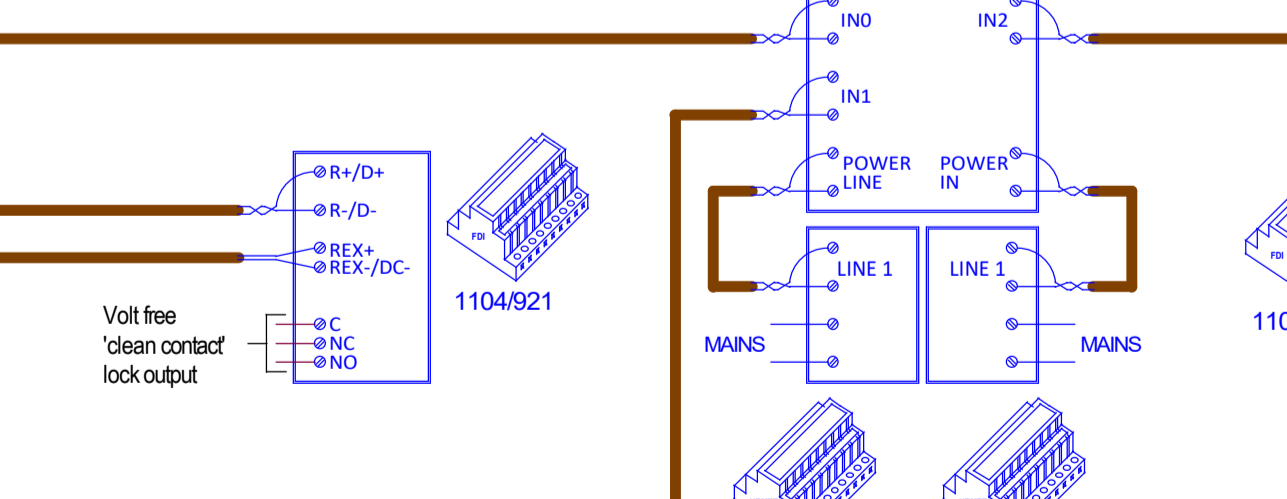
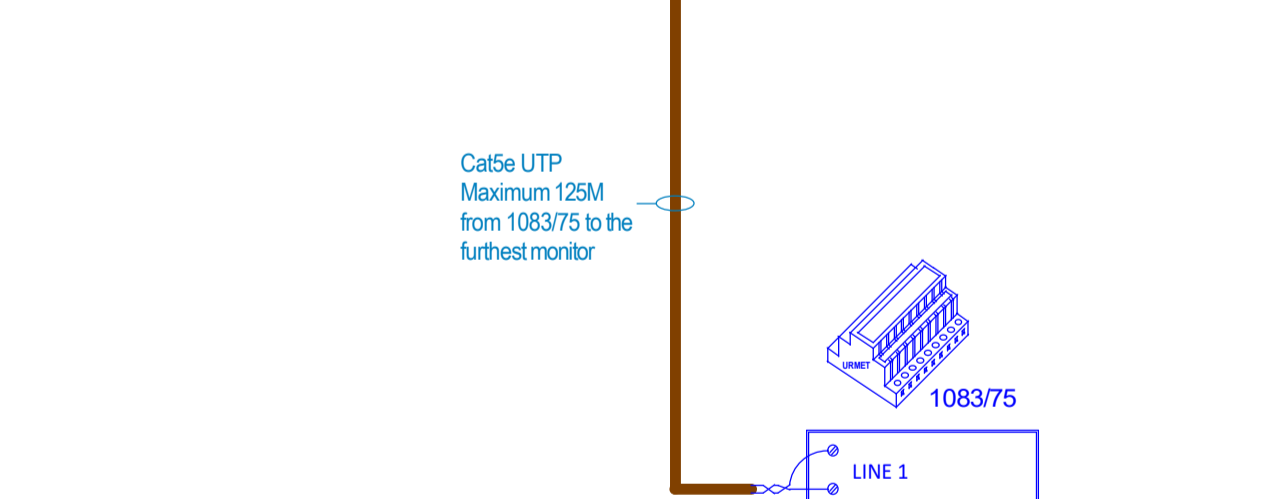
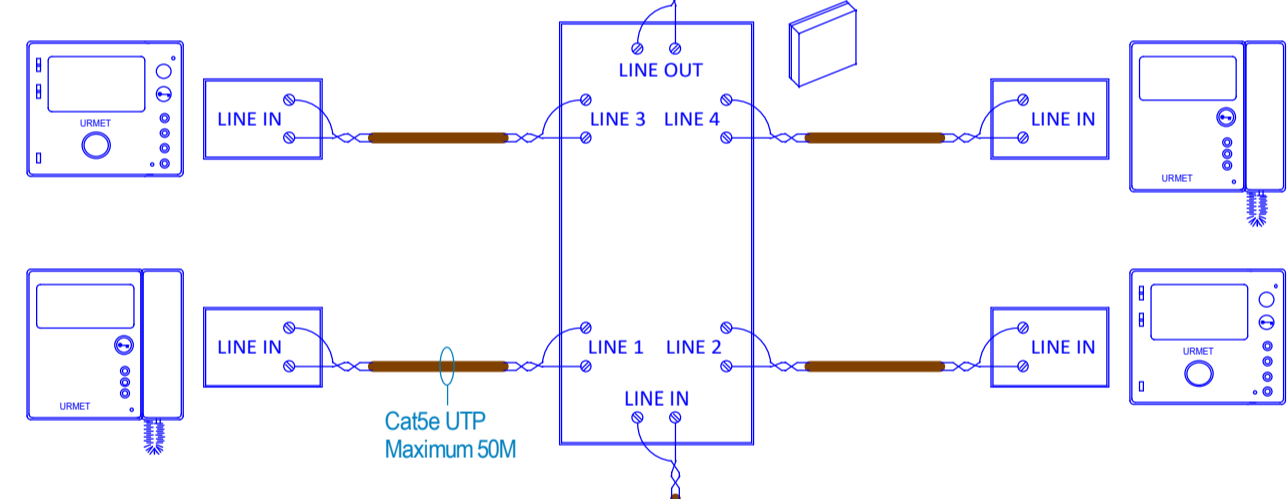
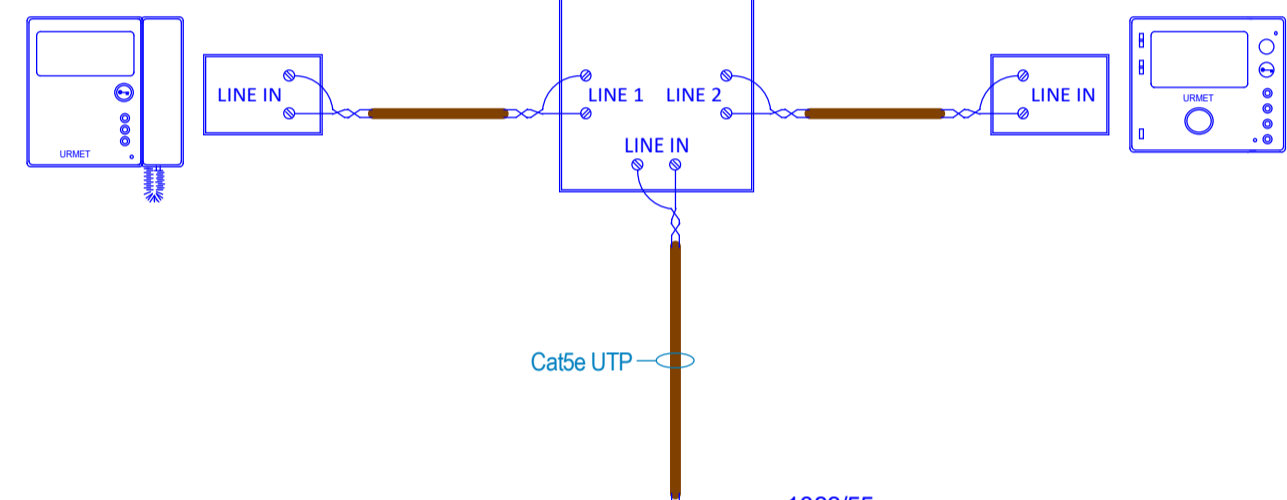
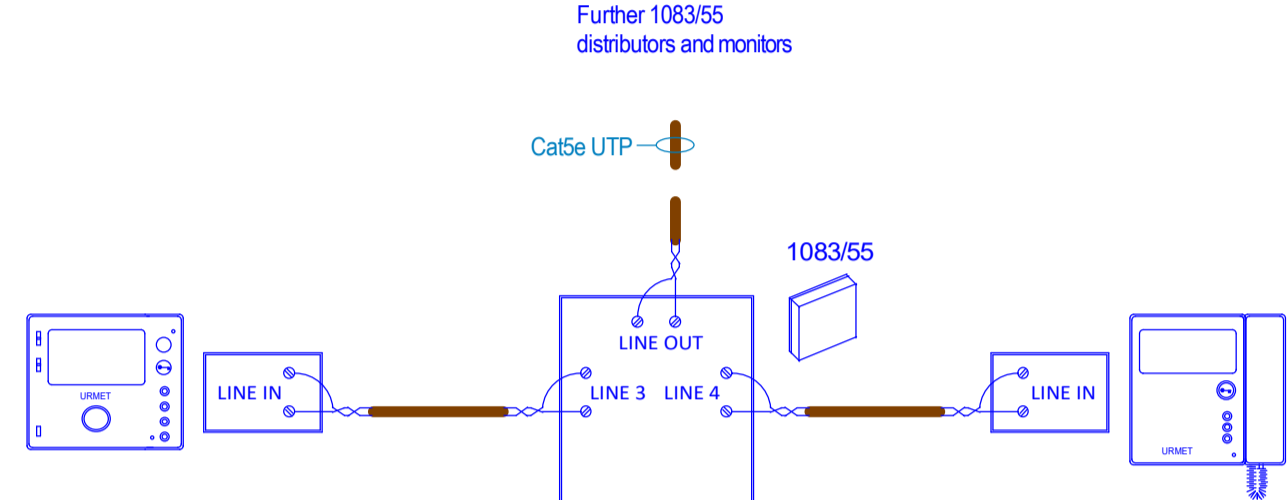
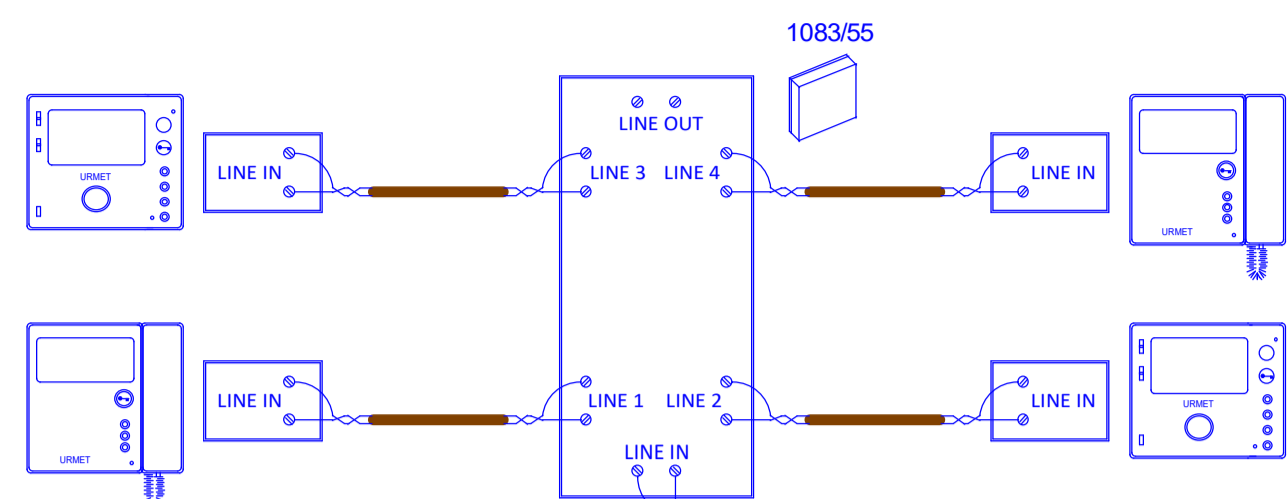

The maximum 'cable extension' or maximum total amount of cable in the 2Voice system is 800M.

For example -

Entry panel 1 to 1083/75 = 100M  
 Entry panel 2 to 1083/75 = 15M  
 Entry panel 3 to 1083/53 = 25M  
 1083/75 to the last 1083/55 distributor = 40M  
 1083/55 distributor to monitor = 15M (multiplied by eg 40 apartments) = 600M.

100M + 15M + 25M + 40M + 600M = 780M cable extension.

If you calculate the 'cable extension' to be over 800M, please contact Urmet Technical Support.

Note that cables for electric releases, proximity readers etc do not need to be included in the cable extension calculation.

**NOTES:**

- This schematic is for guidance only and should not be used for installation
- Maximum distance from door entry panel to 1083/75 is 100m using Cat5e cable
- Maximum distance from 1083/75 to the monitor is 125m using Cat5e cable
- Maximum distance from 1083/55 to the monitor is 50m using Cat5e cable
- Spare cores in Cat5e cable must not be used for other services -

- Add a cable for the electric release -

- Cabling for double pole push to exit switch, double pole break glass unit and maglock -

- Up to four monitors can be connected to ring together -

Online training available here -



Urmet Communication & Security UK Ltd  
 Urban Hive, Avenue West  
 Skyline 120  
 Great Notley  
 Essex  
 CM77 7AA  
 www.urmet.co.uk